

SOLARX™ Series. Deep-cycle Sealed Solar batteries

SOLARX™ Series - XUNZEL

Sealed maintenance-free Deep-cycle solar batteries specially designed for solar photovoltaic, wind, back-up and industrial applications.

Characteristics

Robust and safe deep-cycle batteries, specifically designed and manufactured for repeated and continuous deep cycle charging and discharging applications. With excellent deep discharge recovery. (IEC61427 solar cycles: 2000 cycles). With No Memory Effect.

Maintenance-free. Sealed, no risk of spillage and 100% safe. AGM Lead-acid batteries with valve regulated and absorbent fiberglass mesh construction - AGM without leakage. No gas formation with normal use.

Can be installed anywhere. Designed for **multi-position installation**.

Delivered with the screws terminals and end caps.

Long Average Service Life Design (up to 10-12 years) and higher cycle life stability. Stable quality. Reliable. Thick plates of excellent quality, resistant to corrosion throughout their service life.

Very low self-discharge. High initial capacity and easy start-up. Longer time to store without use. Up to 12 months without recharging. Low and stable internal resistance.

Ideal for demanding solar, wind, backup, industrial, electronic equipment power supply, UPS, telecommunications, IoT/IIoT and high discharge current applications such as inverters, motors and automatisms, ...

Models made with special materials for non fire propagation (XUNZEL UL94 V-0 certified)

Excellent behaviour at extreme temperatures: -20° to +60°C

Demanding design guaranteed with the highest level of certifications:

IEC/EN61427 | IEC/EN60896 | IEC/EN61056
 IEC/EN61000 EMC Directive
 IEC/EN60896 LVD Directive
 ISO9001 | UL94

SOLARX Series are safe and conform to UN2800 (NON-SPILLABLE)

Valid for any transport: air (IATA and FAA), maritime (IMDG), rail and land (ADR/RID)



© Copyright 2022 XUNZEL™ reserves the right to make changes and improvements without prior notice. Specifications are subject to change without further notification
 XU-92220226-MA

Industry Leading Technology for Off-Grid, Off-Shore and Backup Power Applications





SOLARX™ Series. Deep-cycle Sealed Solar batteries

Specifications

Model	SOLARX-3	SOLARX-8	SOLARX-14	SOLARX-23	SOLARX-30	SOLARX-48	SOLARX-78	SOLARX-120	SOLARX-170	SOLARX-240	SOLARX-290
Code Order Part Number	SOLARX3	SOLARX8	SOLARX14	SOLARX23	SOLARX30	SOLARX48	SOLARX78	SOLARX120	SOLARX170	SOLARX240	SOLARX290
Nominal Voltage	12V (6 Cells)										
Chemistry	Lead-acid (AGM)										
Battery Type	Rechargeable - Secondary – With No Memory Effect										
Average Service Life	10-12 years (at 20°C)										
Capacity (DoD 1.75V/cell) @ 25°C											
C10	2.20Ah	6.75Ah	11.50Ah	18.75Ah	25.20Ah	39.00Ah	62.50Ah	98Ah	143Ah	195Ah	230Ah
C20	2.45Ah	7.00Ah	12.50Ah	20.10Ah	26.00Ah	42.00Ah	68.30Ah	105Ah	150Ah	210Ah	260Ah
C100	2.65Ah	7.87Ah	13.80Ah	22.30Ah	29.20Ah	47.20Ah	76.70Ah	118Ah	166Ah	236Ah	288Ah
C120	3.00Ah	8.00Ah	14.00Ah	23.12Ah	30.00Ah	48.00Ah	78.00Ah	120Ah	169Ah	240Ah	293Ah

Weight and Dimensions

Weight (kg)	0.97	2.00	3.60	5.40	8.50	14.90	21.00	31.20	44.00	62.50	74.00
Length (mm)	177	151	151	181	176	198	350	328	483	522	521
Width (mm)	35	65	98	77	166	166	167	172	170	240	268
Height (mm)	62	94	95	167	125	169	182	215	241	219	220
Total height (mm)	66	100	101	167	125	169	182	220	241	224	225
Internal resistance (Approx.)	45mΩ	27mΩ	14mΩ	15mΩ	9mΩ	7mΩ	5mΩ	4mΩ	5mΩ	3mΩ	4.5mΩ

Self-discharge The batteries SOLARX™ can be stored up to 8 months at 20°C average monthly temperature. Recharging is recommended every 6 months. Self-discharge approx. 2.5-3% per month at 20°C Charge the battery before use.

Operational Temperature Range. Environmental

Discharge	-20°C ~ 60°C	-40°C ~ 60°C
Charge	0°C ~ 50°C	-20°C ~ 50°C
Storage	-20°C ~ 60°C	-40°C ~ 60°C
Operational Nominal Temperature	25 ± 5 °C	
Recommended Operational Temperature Range	10°C a 30°C	
Operating altitude	0..3000 m	

Operational Currents

Maximum Discharge Current (5s)	23A	70A	120A	200A	260A	400A	650A	1000A	1500A	2000A	2600A
Recommended Maximum Charge Current	0.69A	2.10A	3.60A	6.00A	7.80A	12.00A	19.50A	30.00A	45.00A	60.00A	60.00A

Charging Voltage

Absorption (@ 25°C)	14.40-14.70V										
Flotation (@ 25°C)	13.70-13.90V						13.60-13.80V				
Equalization (@ 25°C)	14.60-14.80V										
T ^α effect in Charging Voltage	-3mV/K per cell (6 cells)						-4mV/K per cell (6 cells)				

Terminals	Faston Tab F1	Faston Tab F2	M5 (6~7 N·m)				M6 (8~10 N·m)		M8 (10~12 N·m)		
Case material	A.B.S. (UL94 V-0)							A.B.S. (UL94 V-0 Optional. Available on request)			
Hangers	N/A						Integrated				
Standards	CE UKCA RoHs3 and REACH Compliant WEEE Compliant IEC/EN61427 IEC/EN60896 IEC/EN61056 IEC/EN61000 EMC Directive IEC/EN60896 LVD Directive ISO9001 UL94										

Capacity factors for different average temperatures:

-20°C (-4°F)	-10°C (14°F)	0°C (32°F)	5°C (41°F)	10°C (50°F)	20°C (68°F)	25°C (77°F)	30°C (86°F)	40°C (104°F)	45°C (113°F)
46%	66%	76%	83%	90%	98%	100%	104%	107%	109%



© Copyright 2022 XUNZEL™ reserves the right to make changes and improvements without prior notice. Specifications are subject to change without further notification
XU-92220226-MA

Industry Leading Technology for Off-Grid, Off-Shore and Backup Power Applications



info@xunzel.com
www.xunzel.com



SOLARX™ Series. Deep-cycle Sealed Solar batteries

Number of solar cycles in relation to Deep of Discharge (DoD) %
Cycles IEC61427: 2000 cycles

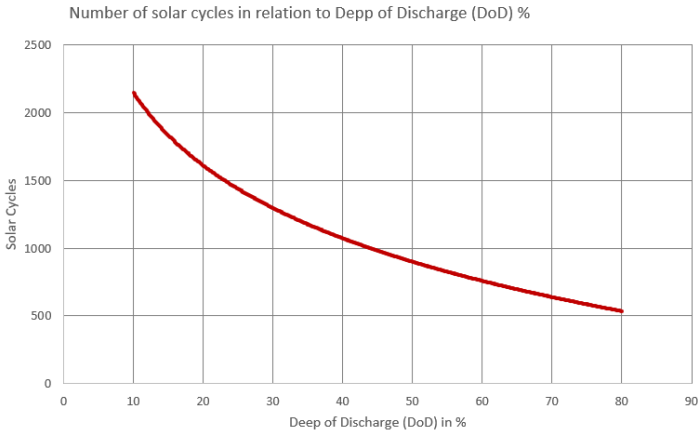

Discharge Curves
Temperature 25°C (77°F)

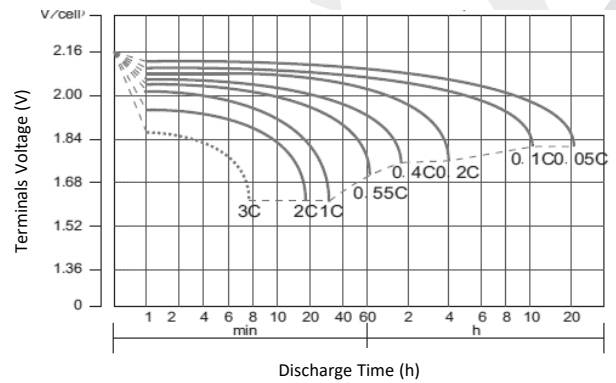

Charging curves
Temperature 25°C (77°F)

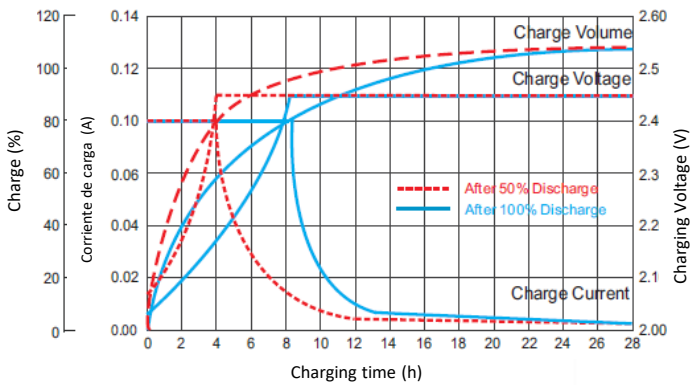

Guide and Curves Characteristics Auto-Discharge for storage and charge.
Monthly average temperature. Auto-discharge: approx. 2.5-3% per month at 20°C (68°F)

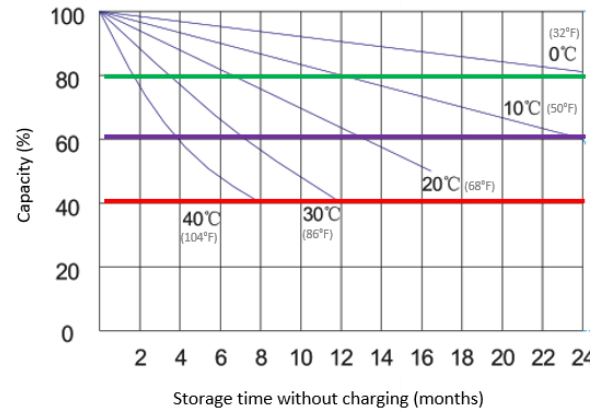

Temperature effect on battery life

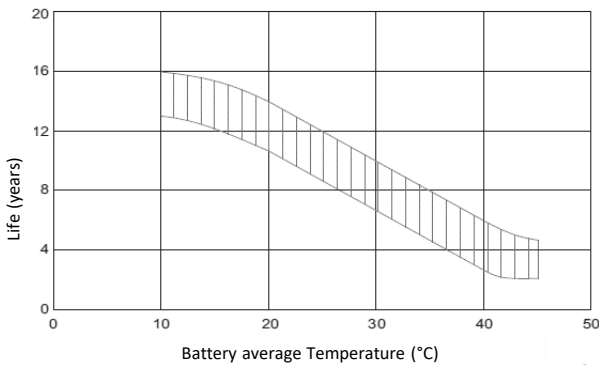

Battery voltage function State of Charge (%)

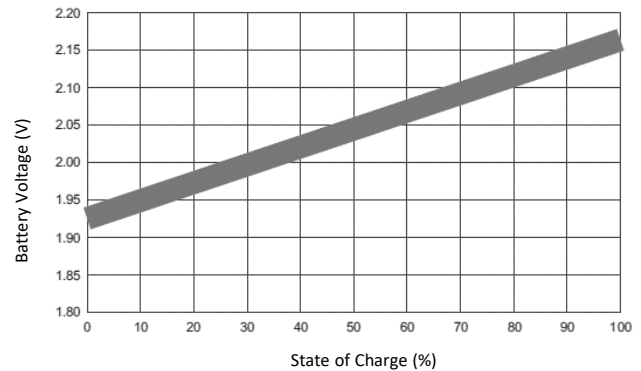

© Copyright 2022 XUNZEL™ reserves the right to make changes and improvements without prior notice. Specifications are subject to change without further notification XU-92220226-MA

Industry Leading Technology for Off-Grid, Off-Shore and Backup Power Applications





SOLARX™ Series. Deep-cycle Sealed Solar batteries

Drawings

Units: mm

SOLARX-3

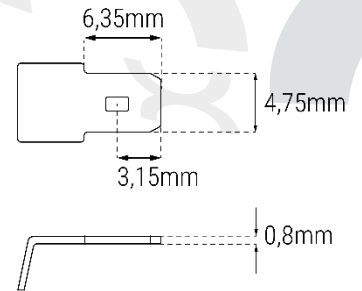
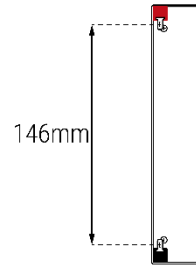
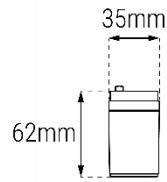
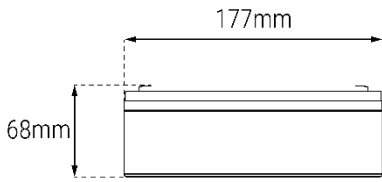

SOLARX-8

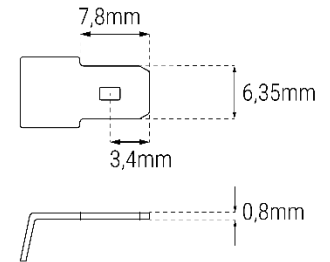
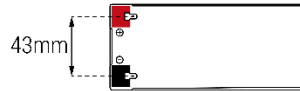
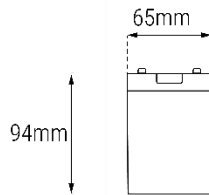
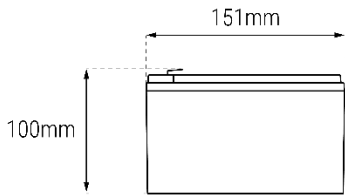

SOLARX-14

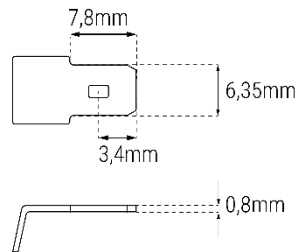
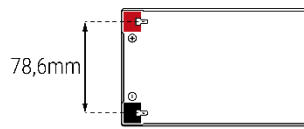
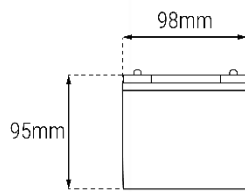
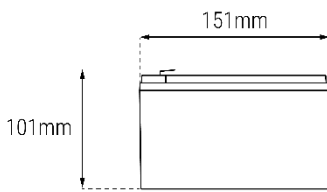

SOLARX-23

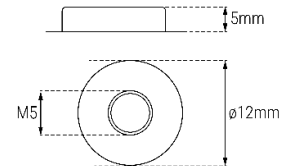
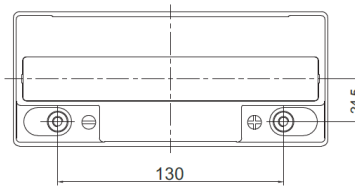
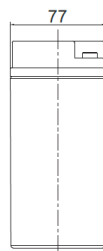
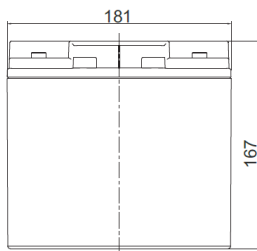

The design and all photos and drawings on these sheets are protected by law and may not be distributed or reproduced, in whole or in part, or published or used for any purpose without the express written consent of XUNZEL. © XUNZEL - Xunzel is not responsible for any typographical errors.

© Copyright 2022 XUNZEL™ reserves the right to make changes and improvements without prior notice. Specifications are subject to change without further notification. NOT IN SCALE

XU-92220226-MA

Industry Leading Technology for Off-Grid, Off-Shore and Backup Power Applications



info@xunzel.com
www.xunzel.com

© Copyright Xunzel. Information contained in this document is subject to change without notice.



SOLARXTM Series. Deep-cycle Sealed Solar batteries

Drawings

Units: mm

SOLARX-30

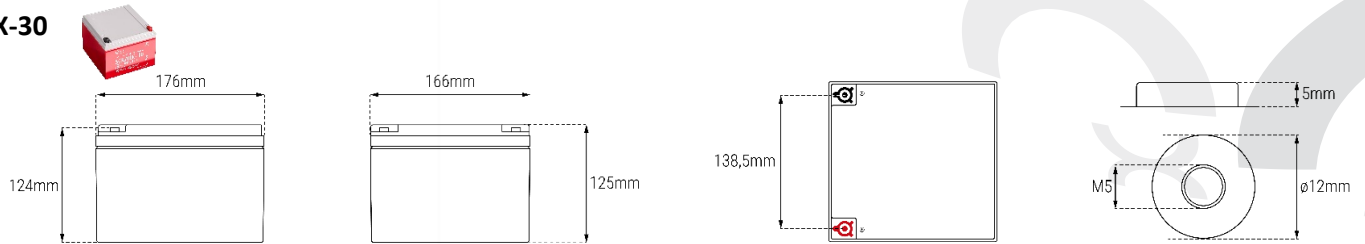

SOLARX-48

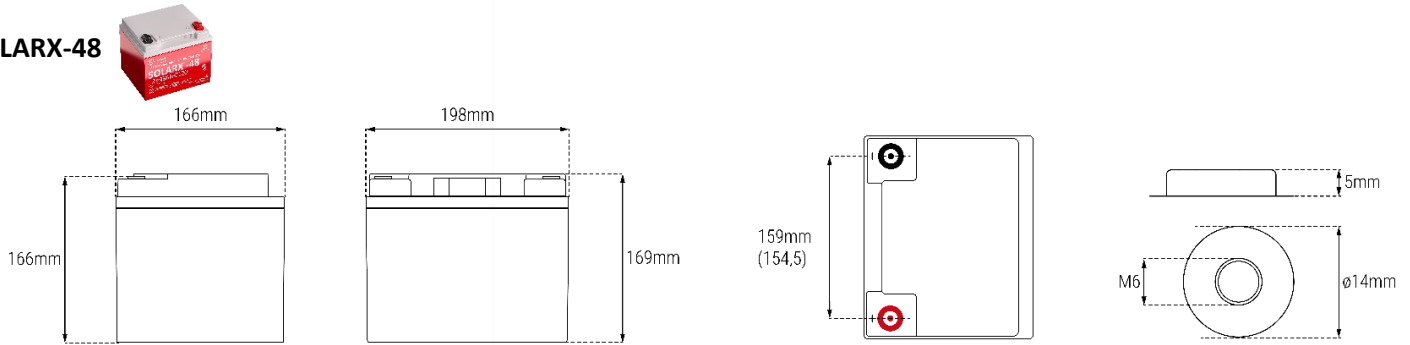

SOLARX-78

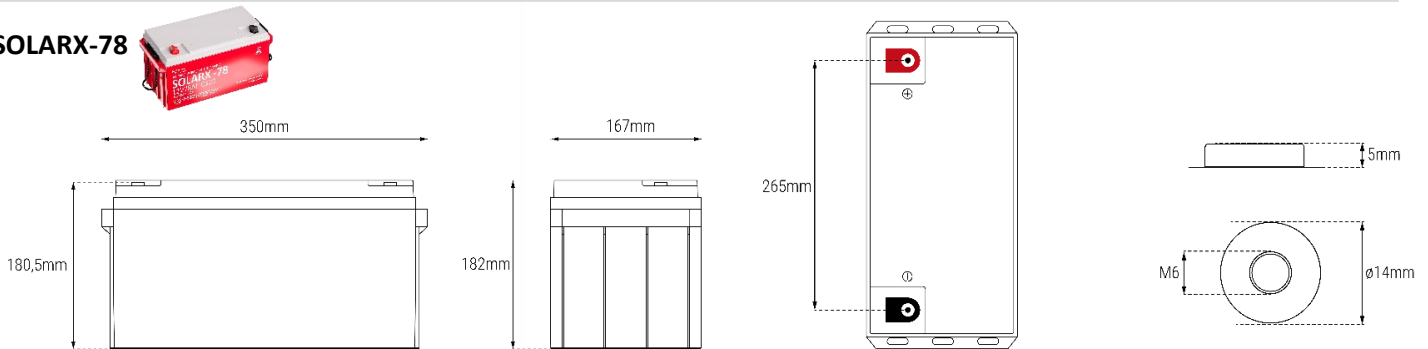

SOLARX-120

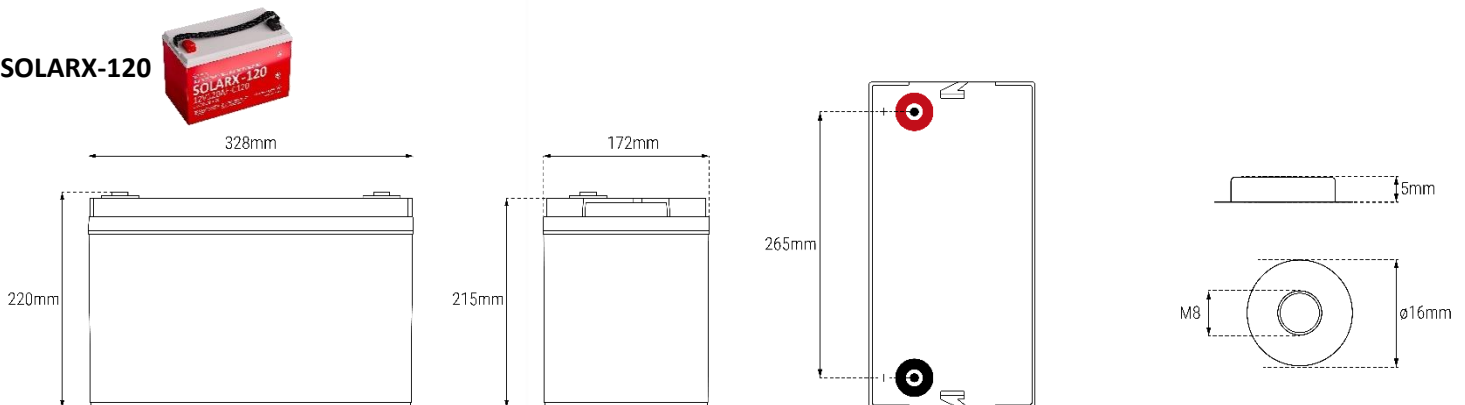

The design and all photos and drawings on these sheets are protected by law and may not be distributed or reproduced, in whole or in part, or published or used for any purpose without the express written consent of XUNZEL.
© XUNZEL - Xunzel is not responsible for any typographical errors.

© Copyright 2022 XUNZEL™ reserves the right to make changes and improvements without prior notice. Specifications are subject to change without further notification. NOT IN SCALE

XU-92220226-MA

Industry Leading Technology for Off-Grid, Off-Shore and Backup Power Applications





SOLARX™ Series. Deep-cycle Sealed Solar batteries

Drawings

Units: mm

SOLARX-170

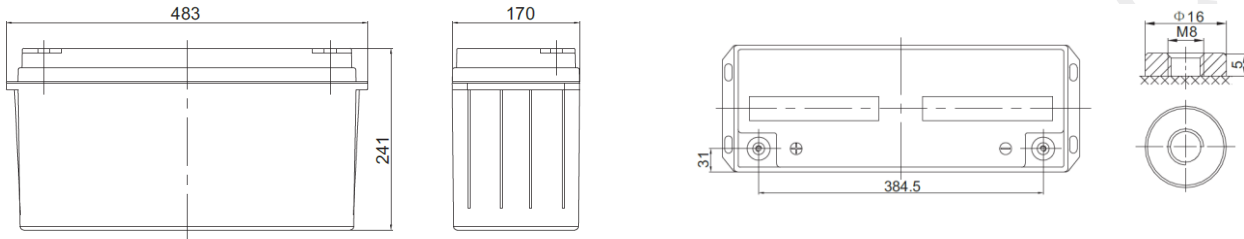

SOLARX-240

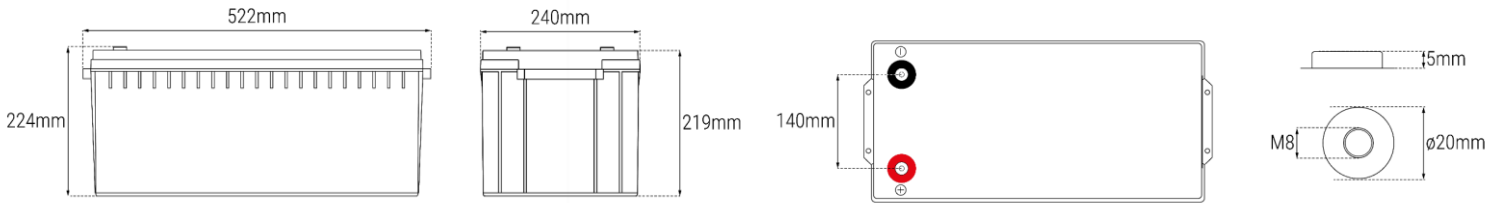

SOLARX-290

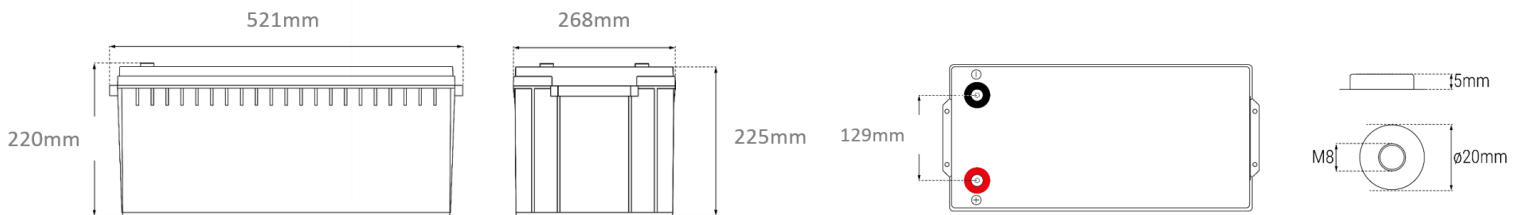

The design and all photos and drawings on these sheets are protected by law and may not be distributed or reproduced, in whole or in part, or published or used for any purpose without the express written consent of XUNZEL.
© XUNZEL - Xunzel is not responsible for any typographical errors.

© Copyright 2022 XUNZEL™ reserves the right to make changes and improvements without prior notice. Specifications are subject to change without further notification. NOT IN SCALE

XU-92220226-MA

Industry Leading Technology for Off-Grid, Off-Shore and Backup Power Applications

